

PART NO.	STOCK CODE	VARIANTS
VBV-110C	A3852	BLACK & WHITE (PAU)
VBV-710C	A1379A	COLOR (PAU)
VBV-711C	A2575	COLOR (NTSC)
VBV-790C	B2722	COLOR (PAU) NO AUDIO

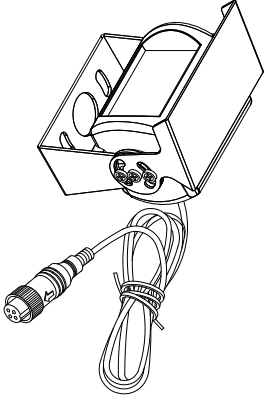
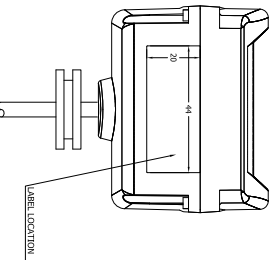
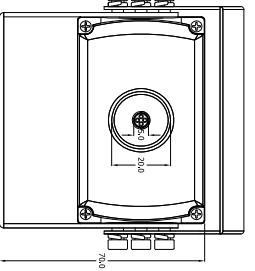
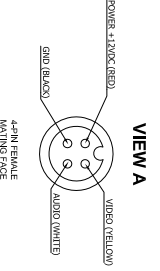
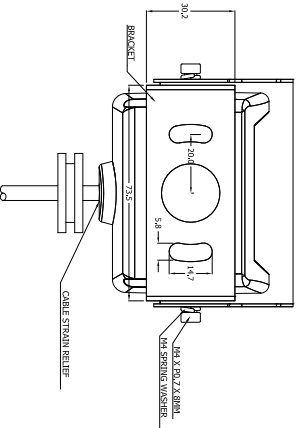
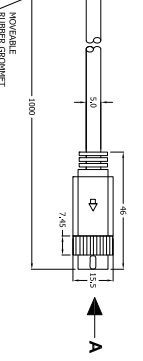
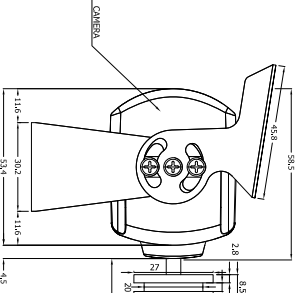
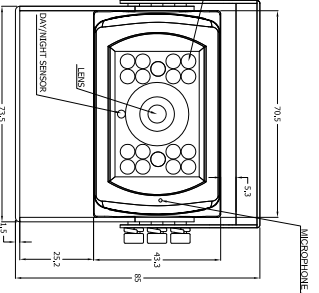
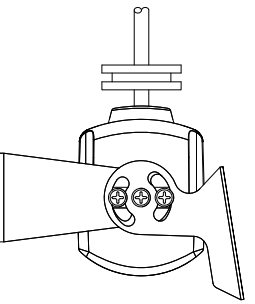
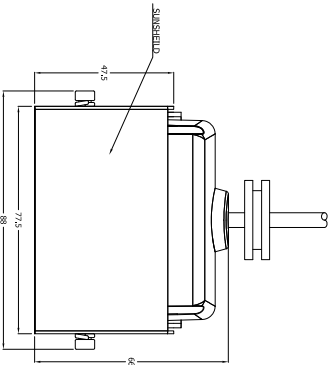

RevNo Revision note Date Signature Checked

NOTES:  
DIMENSIONS IN MM  
REFER TO "PRODUCT SPECIFICATION" FOR MORE DETAILS

PROPRIETARY NOTICE  
THIS DESIGN AND TECHNICAL INFORMATION APPEARING ON THIS DRAWING IS THE PROPERTY OF BRIGADE ELECTRONICS PLC, AND IS DISCLOSED IN CONFIDENCE. IT IS NOT TO BE COPIED, REPRODUCED, REVEALED TO OR APPROPRIATE BY OTHERS, EITHER IN WHOLE OR IN PART, WITHOUT THE EXPRESS WRITTEN CONSENT OF BRIGADE ELECTRONICS PLC.

Item#	Quantity	Title/Name, designation, material, dimension etc	Article No./Reference
Designed by M.BUTLER	Checked by DKRBAI	Approved by - date S.MATTHEWS	Filename 13/02/09
BRIGADE ELECTRONICS			Article No./Reference VBV-110C (A1852)
BE-000634-00-09			Edition A
			Scale 1/1